

proceq



profometer 5⁺

Modell S / SCANLOG

Bewehrungs-Suchsystem

Rebar Detection System

Système de détection d'armatures



Bedienungsanleitung

Operating Instructions

Mode d'emploi

ISO
9001

proceq

Proceq SA
Ringstrasse 2
CH-8603 Schwerzenbach
Switzerland

Tel. +41-43-355-38-00
Fax +41-43-355-38-12
info-europe@proceq.com

Proceq USA, Inc.
117 Corporation Drive
Aliquippa, PA 15001
USA

Phone +1-724-512-0330
Fax +1-724-512-0331
info-usa@proceq.com

Proceq Asia Pte Ltd
12 New Industrial Road #02-02A
Singapore 536202
Republic of Singapore

Phone +65-6382-3966
Fax +65-6382-3307
info-asia@proceq.com

www.proceq.com

Subject to change without notice

English

Contents

1	Safety	2	Measure with Statistics	9	
	General Information	2	Scanning Bars	9	
	Liability	2	Measure with Grid	9	
	Safety Regulations	2	5	Measuring Process	9
	Standards and Regulations Applied	2		Measure with Statistics	9
2	Product Description	3		Detecting Insufficient Concrete Cover	12
	Model S (Basic Unit)	3		Determining the Bar Diameter	13
	Model SCANLOG	3		Making Reinforcement Visible with CyberScan ..	14
	Universal Probe	4		Measure with Grid	17
	ScanCar	5		Data Output	20
3	Startup	6	6	Maintenance and Storage	22
	Connecting the Components	6		Cleaning	22
	Putting the Indicating device into Operation	6		Performance Check	22
4	Settings	6		Storage	22
	Bar Diameter	6	7	Data	23
	Object Number	7		Form of Delivery	23
	Limit Value	7		Accessories / Spare Parts	24
	Corrections	7		Technical Data	24
	Language	8			
	Basic Setups	8			
	Data Output	8			

1 Safety

1.1 General Information

1.1.1 Basic Information

The rebar locator complies with state-of-the-art technology and the recognized safety regulations.

Please read through these operating instructions carefully before initial startup.

1.1.2 Designated Use

The rebar locator is used for the non-destructive location of rebars and for the measurement of concrete cover and bar diameters.

1.2 Liability

Our «General Terms and Conditions of Sale and Delivery» apply in all cases. Warranty and liability claims arising from personal injury and damage to property cannot be upheld if they are due to one or more of the following causes:

- Failure to use the rebar locator in accordance with its designated use
- Incorrect startup and operation of the rebar locator
- Unauthorized structural modifications to the rebar locator
- Serious damage resulting from the effects of foreign bodies, accidents, vandalism and force majeure

1.3 Safety Regulations

1.3.1 Unauthorized Operators

Anyone who is not familiar with the operating instructions must not use the rebar locator or must be supervised when using it.

1.3.2 Safety Icons

The following icons are used in conjunction with all important safety notes in these operating instructions.



Warning!

This note warns you about the risk of material damage, financial loss and legal penalties (e.g. loss of warranty rights, liability cases, etc.).



This denotes important information.

1.4 Standards and Regulations Applied

SIA 162 / DIN 1045 / DGZfP B2 / BS 1881: Part 204

2 Product Description

2.1 Model S (Basic Unit)

The PROFOMETER 5+ rebar locator is a lightweight, compact device for the non-destructive location of rebars and for the measurement of concrete cover and bar diameters.

The measuring method is based on the eddy-current principle with pulse-induction.

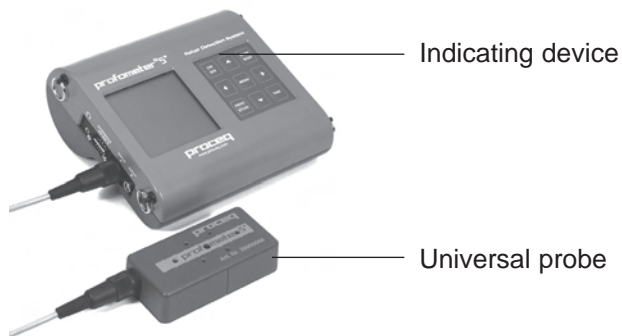

Fig. 2.1 Model S

The basic unit can perform the following functions:

- Locating rebars
- Measuring concrete covers
- Storing individual cover values and statistical evaluation
- Determining the bar diameters

2.2 Model SCANLOG

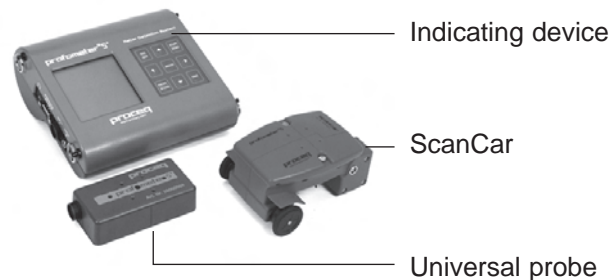

Fig. 2.2 Model SCANLOG

The SCANLOG rebar locator is identical to model S and comprises the following additional functions:

- «CyberScan» function for displaying the concrete cover
- «Measure with Grid» function for grey-scale display of the concrete cover
- ScanCar probe carriage with integral path measuring device for scanning the rebars
- Storage areas for «CyberScan» and «Measure with Grid» objects

In the case of both models, the data can be printed directly on a printer connected to the indicating device or transferred to a PC.

2.3 Universal Probe

2.3.1 Functioning

The universal probe is designed to function in relation to the direction. This means it reacts most sensitively to the rebars parallel to its longitudinal axis, and least sensitively to the ones at right angles to its longitudinal axis. For this reason the probe should be positioned parallel to the bars to be tested and moved over them sideways for scanning.

The probe has both a small and a large measuring range. Use the ← and → keys to switch over between the two measuring ranges. The active measuring range is displayed in the measuring display (see Fig. 5.1). The large measuring range should only be used if the concrete cover is larger than is shown in the intersection point of the curves in Fig. 2.4. If the bar diameter is 16 mm, this applies for a cover of approx. 60 mm.

2.3.2 Measuring Ranges and Accuracy

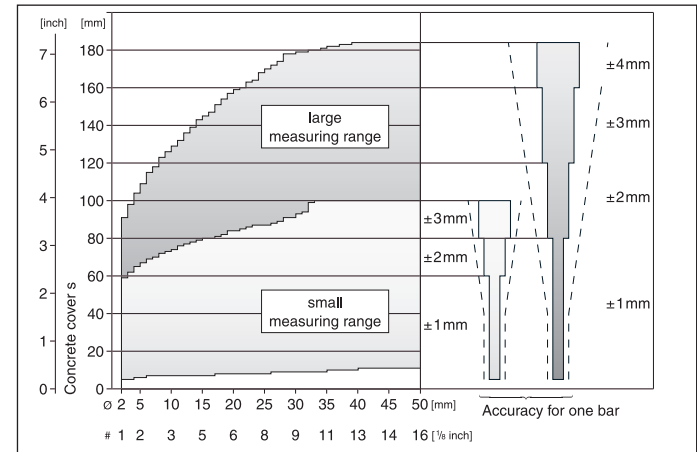

Fig. 2.3 Measuring ranges and accuracy of the universal probe

Key:

Ø: Bar diameter in mm

#: Bar diameter in «Bar size #»

---: Lowest accuracy limit required by the standard
BS 1881: Part 204: ±2 mm or ±5 %

PROFOMETER 5+ measures up to 50 % more accurately than required by this standard.

The size of the two measuring ranges of the universal probe depends on the bar diameters. The accuracy of the concrete cover indication refers to individual bars. See also Fig. 2.4.

2.3.3 Resolution

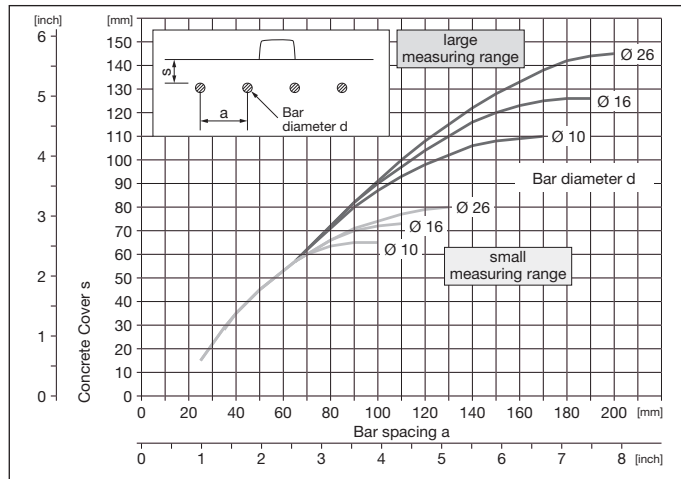

Fig. 2.4 Resolution

On concrete elements, measurements are often influenced by neighboring bars. For parallel bars in the same layer, the diagram in Fig. 2.4 shows the smallest bar spacings a at which rebars are still identifiable individually in relation to concrete cover s . For intersection points of the bar spacing a and concrete cover s above the corresponding curve the current value indicates the approximate depth of the reinforcement level. For possibility for correction, see «Corrections», page 7.

Example of bars in a position which can still be located: Bar diameter $d = 16$ mm, concrete cover $s = 55$ mm and smallest bar spacing $a = 70$ mm.

2.4 ScanCar

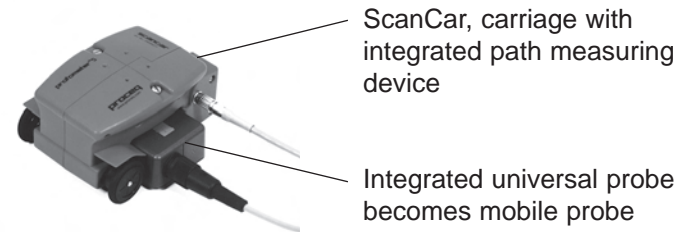

Fig. 2.5 ScanCar with integrated universal probe

For the SCANLOG model, the ScanCar is required to perform the «CyberScan» and «Measure with Grid» functions. For model S, it can be used as a carriage without any other functions.



If the path measuring cable is connected, the air gap of 4 mm between the probe and the concrete surface is automatically corrected when the concrete cover is displayed.

3 Startup

3.1 Connecting the Components

- Connect the universal probe to input A.
- If you want to use the ScanCar probe carriage, connect it to input B.
- If you use a headset, connect it to the socket marked with the headset symbol.

3.2 Putting the Indicating device into Operation

- Press the ON/OFF key.
The following data is briefly displayed:
 - Instrument model (model S or SCANLOG)
 - Instrument serial no.
 - Installed software version
 - Whether automatic self-test is O.K.
 - The more or less black battery symbol indicates the battery status

Then the measuring display of the previously measured object appears (Fig. 5.1, Fig. 5. 7 and Fig. 5.13)
When the measuring display is visible the backlight of the LCD can be turned on and off by pressing the ↑ key for more than 2s.



If no display appears, replace the batteries.

4 Settings

The indicating device has a user menu navigation. Please follow the instructions in the display fields.

- Press the MENU key to display the main menu:

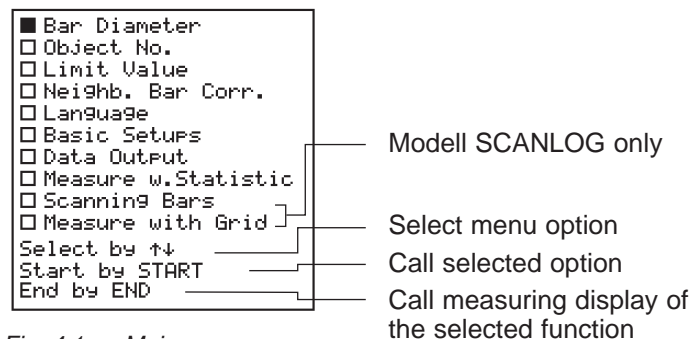

Fig. 4.1 Main menu

4.1 Bar Diameter

Setting the bar size that exists on the structure makes a good basic accuracy of the cover readings possible. The suggested default size is 16mm or #5. The bar diameter setting can be done in metric units and US bar size numbers.

Metric System

The bar size can be increased in mm. This makes it possible to set bar diameters according to different

standards. The instrument indicates concrete cover depth and distances in [mm] and [m] respectively.

US System of Units

In this system the bar sizes must be set in numbers 01 to 16. The «bar size #» specifies the diameter in eighths of an inch. In this mode the instrument indicates cover depth and distances in inches and feet.

Example: Bar size #5 corresponds to a diameter of 5/8" (15.9mm).

- To switch from mm to inches press the MENU key and subsequently select «Basic Setups» and «Unit»

4.2 Object Number

The measured values can be stored under object numbers. The following number is set automatically as the first digit of the six-figure object number according to the measuring function:

- 1 for «Measure w. Statistics»
- 2 for «Scanning Bars»
- 3 for «Measure with Grid»

4.3 Limit Value

For description, please see under «Measure with Statistics», page 9 and «Detecting Insufficient Concrete Cover», page 12.

4.4 Corrections

Neighboring bar corrections

This mode is mainly used for determination of the bar diameter in close spaced parallel bar arrangements. There are structures where the bar spacing is smaller than indicated in Tab. 5.2. When measuring these bars, the displayed value of the concrete cover is too low and the diameter value too high. In such instances, corrections can be made. This however only applies to the parallel bars on both sides. The bars that are arranged crosswise must have the minimum spacing shown in Tab. 5.2.

- Enter the previously determined bar spacing. See «Measure with Statistics», page 9, «Detecting Insufficient Concrete Cover», page 12, «B. Determining diameters with correction», page 14, «Making Reinforcement Visible with CyberScan», page 14 and «Measure with Grid», page 17.

2-Layer-Correction

This mode is used for cover measurement in congested standard orthogonal bar arrangements. A more accurate cover reading can be reached by use of this correction. The congested bars induce a too strong measuring signal which can be corrected this way.

- Select the spacings a and b which you determined by locating the bars. In some cases the bar diameters cannot be measured by the PROFOMETER 5+ and must be determined by removing the concrete. The diameter setting is automatically selected as 16mm.

This mode can only be activated in measuring function «Measurement with Statistics».

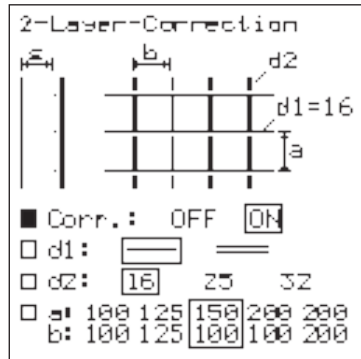

2-Layer-Correction

4.5 Language

The language of the display texts can be selected.

4.6 Basic Setups

The following settings are possible:

- Unit

If you choose «mm» the bar diameter setting can be selected in mm and the results will be indicated in the metric system. If you chose «inch» the bar diameter setting can be made in bar size numbers and the results are indicated in imperial units. Please refer also to «Bar Diameter» on page 6.



Warning!

By changing the unit from mm to inch or vice versa existing measured and stored values are falsified. In order to avoid confusing results the user must clear the memory after changing the units.

The mode «2-Layer-Correction» can only be used for metric units.

- Probe



When starting up the device for the first time, the code no. engraved on the probe must be entered in the submenu «Probe».

- Audible locating aid

(Short) beep tone selectable in two frequencies or Variotone can be selected.

The remaining settings are described under the respective functions.

4.7 Data Output

For description, please see under «Data Output», page 20.

4.8 Measure with Statistics

For description, please see under «Measure with Statistics», page 9.

4.9 Scanning Bars

Model SCANLOG only

For description, please see under «Making Reinforcement Visible with CyberScan», page 14.

4.10 Measure with Grid

Model SCANLOG only

For description, please see under «Measure with Grid», page 17.

5 Measuring Process

5.1 Measure with Statistics

This function can be used to locate rebars, measure concrete covers and determine bar diameters. The cover values can be stored under object numbers.

5.1.1 Rebars Connected with Binding Wires

Settings

See also under «Settings», page 6.

- Enter the bar diameter.



If the bar diameter is unknown, enter 16 mm.

- Enter the object number.

Limit value: To avoid confusions, set the limit value to «0» during the measuring process. Enter the value required for the building after completion of the series of measurement. The percentage of the covers that are too small will be displayed in the statistical evaluation. See also «Detecting Insufficient Concrete Cover», page 12.

- Enter the desired audible locating aid («MENU» → «Basic setups» → «Audible locating aid»): (Short) beep tone or variotone.
- Enter the requested values under the menu option «Corrections» → «Neighbouring Bar Correction» or «2-Layer-Correction» if the correction is required.
- Select the «Measure w. Statistics» function.
- Press the START/RESET key.

The measuring display appears:

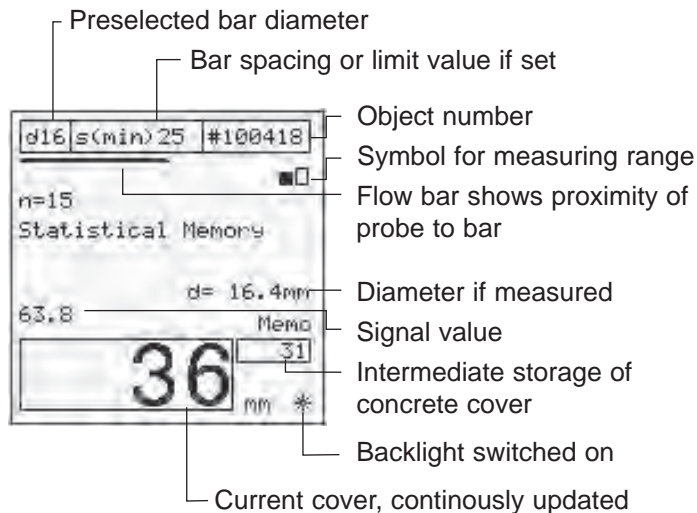

Fig. 5.1 Measuring display «Statistics»

If required the backlight of the LCD can be switched on. This can be done by pressing key \uparrow for more than 2s.

RESET process

- Hold the probe in the air and press the START/RESET key. A bar appears in the display that informs you on the progress of the procedure. The probe shall not be moved before the bar has disappeared and «0» is displayed.
- Please repeat this check procedure from time to time.

Locating the rebars and measuring the concrete cover

For locating the rebars, the diameter setting is not as important as for measuring the cover.



In the case of double layer arrangements of rebars, always start the location with the first layer.

If the rebars of the first layer are too close to each other, it is likely to be impossible to locate the bars of the second layer. See also «Universal Probe», page 4.

- Move the probe from a starting position in one direction. Observe the locating aids: current concrete cover, flow bar, (short) beep, variotone, signal value. As long as the flow bar moves to the right, the probe is approaching a rebar. If the flow bar stops moving, the probe is directly over the rebar axis. If the centerline of the probe has overshoot the rebar axis somewhat, acoustic and visual indication is given in the «beep» setting by a short beep and by «—» in the «Current cover» display field. At the same time, the flow bar moves to the left and the cover is temporarily stored in the field Memo».
- When having activated the audible locating aid «Variotone» («MENU» → «Basic Setups» → «Audible locating aid»), the audio frequency increases as the probe approaches a rebar. In this operation mode the cover of the scanned rebar is also temporarily stored in the field «Memo».
- In the case of loud noises from the surroundings, use the headset to hear the acoustic signals.



Irrespective of the settings, the signal value is a yardstick for the distance between the probe and a metallic object.

- The bar direction can be detected by moving the probe in the direction of its longitudinal axis along the rebar. Make sure that the signal value and the current cover remain as constant as possible.

Storing the measured values

To store the measured values, select an object number in the menu.

- Press the PRINT/STORE key to store the measured value shown in the field «Memo».
- Use the ↓ key to delete the measured value, or in the case of several values, the last of the remaining measured values.



Warning!

You cannot undo the deletion of a value!

- To receive a statistical evaluation of the stored measured values, press the END key.
- If you then enter a limit value («MENU» → «Limit Value»), the percentage of the measured values which are below the entered limit value is displayed.
- Pressing END again completes the measurement series and starts a new one with an object number that is incremented by 1.

Measuring the diameter

See «Rebars Connected with Binding Wires», page 13.

5.1.2 Welded Reinforcing Meshes

The unit cannot detect whether the rebars are welded to one another or connected with binding wires. The two reinforcement types with the same dimensions however create different signals.

Settings

- Proceed as described under «Rebars Connected with Binding Wires», page 13.
- Observe the following exception:
The setting of the bar diameter must be slightly higher than the actual diameter (see Tab. 5.1, page 12). The input depends on the bar diameter and on the mesh width. With special constructions, this value should be determined by means of a test on an open system. Use different distance pieces to find out the diameter setting at which the correct cover is indicated.

Examples for diameter settings:

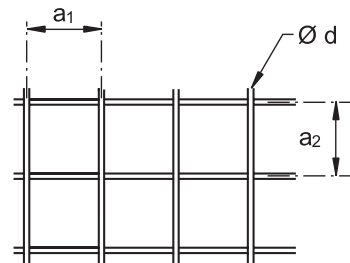

Fig. 5.2 Welded reinforcing mesh

a ₁ [mm]	a ₂ [mm]	current d [mm]	d to be set [mm]
100	100	5	8
150	150	6	7

Tab. 5.1

- Select the small measuring range in the measuring display. The large measuring range cannot be used with welded reinforcing meshes.

Locating and measuring concrete covers

Here, the spacings between the bars of the other layers of the mesh can also be located more easily. This particularly applies to the bars of the second layer.

The value displayed for the cover of a bar of the first layer can vary by a few millimeters depending on whether the measurement is made over the point at which two bars cross, or between the bars of the second layer.



If the rebars of the first layer are too close to each other, it is likely to be impossible to locate the bars of the second layer. See also «Universal Probe», page 4.

Storing the measured values

- Proceed as described under «Storing the measured values», page 11.

Measuring the diameter

«Welded Reinforcing Meshes», page 14.

5.2 Detecting Insufficient Concrete Cover

This function can be used for the following tasks:

- Check after removing formwork
- Building inspection
- Evaluation basis for modernisation

Settings

See also under «Settings», page 6

- Enter the bar diameter.
- Enter the limit value of the cover.
- Enter the bar spacing under the menu option «Neighb. Bar Corr.» if the correction is required. The set limit value is not displayed in this case (see Fig. 5.1).

The setting of the audible locating aid is not of importance.

Measuring the concrete cover

With a preselected limit value, the probe can be moved at a maximum search speed of 0.25 m/s without having to watch the display. If the current cover displayed is less than the limit value, an acoustic alarm sounds. When the probe is over the bar, «—» is indicated in the «Current concrete cover» display field.



Switching off the unit deletes the set limit value.

5.3 Determining the Bar Diameter

5.3.1 Rebars Connected with Binding Wires

A. Determining diameters without correction

For precise determination of the bar diameter, it is important that there are no unnoticed influences that could falsify the result. Therefore select a place on the structure where there is sufficient spacing between the rebars. If the spacings are too small, the resulting value will be too high.

To measure the bar diameter in the first and second layer, the minimum spacings a and b as shown in Tab. 5.2, page 13 are required.

- Select the «Measure w. Statistics» function.
- Carry out the RESET procedure. See also under «RESET process», page 10.
- Place the probe parallel over the bar and press the \uparrow key.
- The result of the bar diameter determination is displayed in mm or inch.

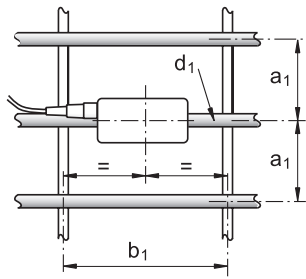

Fig. 5.3 Rebar of 1st layer

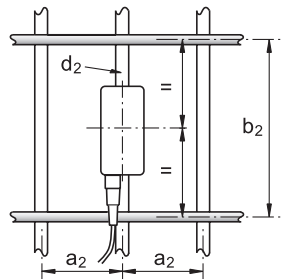

Fig. 5.4 Rebar of 2nd layer

Cover s_1 [mm]	Rebar of 1st layer		Cover s_2 [mm]	Rebar of 2nd layer	
	a_1 [mm]	b_1 [mm]		a_2 [mm]	b_2 [mm]
15	90	200	15	90	180
30	110	200	30	110	220
45	130	210	45	130	240
60	150	250	60	150	260

Tab. 5.2 Minimum spacings of the rebars in the 1st and 2nd layer

Provided that the minimum spacings are observed, the rebars can be measured with an accuracy shown in Fig. 5.5.

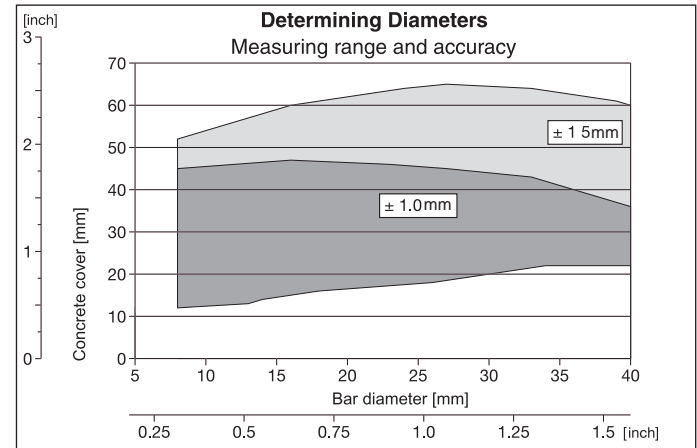

Fig. 5.5 Determining diameters



The result of diameter determination cannot be stored.

B. Determining diameters with correction

There are structures where the rebar spacing is smaller than indicated in Tab. 5.2. Corrections are possible for these structures. However, this only applies to the parallel bars on both sides. The bars that run crosswise must have the minimum spacings shown in Tab. 5.2.

Procedure:

- Locate the parallel rebars carefully and mark them on the surface of the concrete.
- Measure the rebar spacings using a measuring rod and enter the data in the «Corrections» → «Neighb. Bar Corr.»
- Select the «Measure w. Statistics» function.
- Hold the probe in the air and carry out the «RESET process» as described on page 10.
- Place the probe parallel over a bar and press the ↑ key. As bar diameter (d=...), the display shows the value corrected by the influence of the neighboring bars.
- In addition to the bar spacing, the measured bar diameter can now be entered in the menu.

With these settings, the concrete cover of those rebars found to be situated close to one another can be determined precisely.



Only concrete covers can be stored under the selected object number, not the measured bar diameter!

5.3.2 Welded Reinforcing Meshes

If diameters are determined on welded rebar systems, results are displayed most of the time. These values are, however, always too high and cannot be used.

5.4 Making Reinforcement Visible with CyberScan

Model SCANLOG only (with mobile probe)

The rebars arranged below a defined measuring area are displayed. Using the x/y scales, rebars which have to be exposed, or points where holes have to be drilled, can be transferred immediately from the display to the measuring area and marked.

The measuring area must be scanned with the mobile probe once in direction x and once in direction y (see «ScanCar», page 5). The rebars are located and displayed extended to the full size of the measuring area. Measuring areas of 0.5 x 0.5 m, 1 x 1 m or 2 x 2 m can be selected.

If the area that must be measured is smaller than the size of the selected area the bars are only shown in the length they were measured.

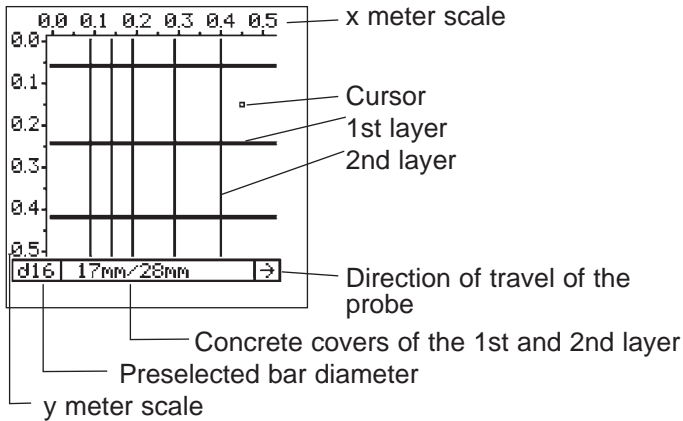

Fig. 5.6 Example of a measured object

Settings

See also «Settings», page 6.

- Enter the bar diameter of the first layer.
- Enter the object number.
- Enter the bar spacing under the menu option «Neighb. Bar Corr.» if the correction is required. The «2-Layer-correction» cannot be used by this function.
- Enter the size of the measuring area («MENU» → «Basic setups» → «Scan Area»).
- Select the measuring function «Scanning Bars».
- Press the START key.

The following measuring display appears:

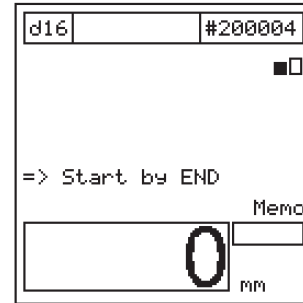

Fig. 5.7 Measuring display «CyberScan»

- Locate a rebar of the first layer in the measuring area and mark it precisely. Then mark the left or top limit of the measuring area parallel to the previously marked bar on the concrete element.



Direction of travel:

The front of the mobile probe is where the single wheel is.

Measuring procedure

- Start with the END key. The following display appears:

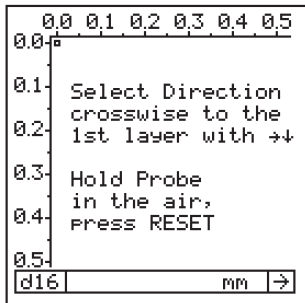

Fig. 5.8 Scanning display

- Determine the direction of travel using the ↓, → keys.
- Position the travel path where the concrete element is to be examined.
- Please note that locating and measuring is in relation to the center of the probe.

- After the measuring area has been scanned, the following is displayed:

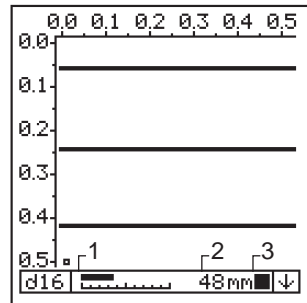

Fig. 5.9 Rebars of 1st layer

- Travelling backwards with the probe deletes the displayed rebars.
- 1 Speed display. The flow bar must be within the scale.
 - 2 Current concrete cover
 - 3 Symbol for travelling and scanning
- The layer measured first is displayed in thicker lines.

- Use the ↑, ↓, ←, → keys to end the measuring process of the 1st layer:

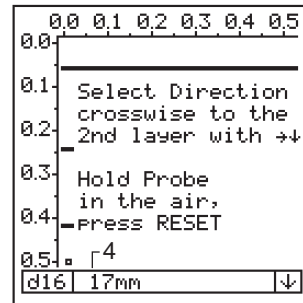

Fig. 5.10 Instructions

- 4 Smallest measured cover of the 1st layer
- Place the cursor between 2 rebars that are as far apart as possible.
 - Mark the position on the measuring area.
 - Start measuring the bars in the 2nd layer from this position.

- After the measuring area has been scanned, the following display appears:

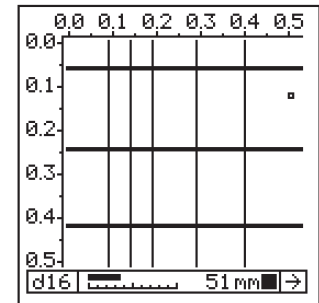

Fig. 5.11 Rebars of 2nd layer

- Use the ↑, ↓, ←, → keys to end the measuring process of the 2nd layer. The smallest concrete cover is indicated.
- Press the PRINT/STORE key to store the measuring display.
- Press the END key if the result must be deleted.

5.5 Measure with Grid

Model SCANLOG only

This function displays concrete covers over a large area in grey scale or colour shades. The smallest concrete cover measured in a grid field is displayed.

Settings

See also «Settings», page 6.

- Enter the bar diameter of the first layer.
- Enter the object number.
- Enter the bar spacing under the menu option «Corrections»
→ «Neighb. Bar Corr.» if the correction is required. The «2-Layer Correction» can not be used by this function.

- Select the size of the grid field («MENU» → «Basic setups» → «xy-grid»).

The grid should usually be greater than the division of the first layer (e.g. +50 %) to ensure that at least one rebar is within a grid field.

- Set the range in which the concrete covers are to be displayed in grey scale («MENU» → «Basic setups» → «Display»).

Change the grey scale range to improve the contrast of the displayed object (see Fig. 5.12).

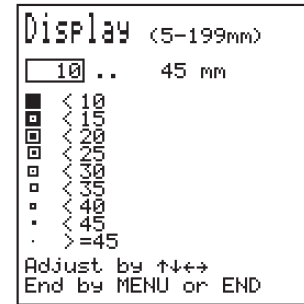

Fig. 5.12 Adjusting grey scale range

The range can be adjusted as desired even after measuring.

- Select the «Measure with Grid» function.
- Pressing the START key calls the measuring display:

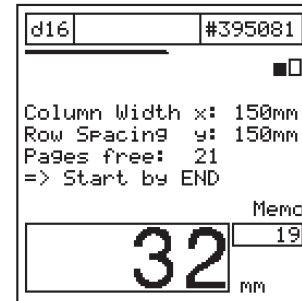

Fig. 5.13 «Measure with Grid» measuring display

5.5.1 Measuring with the Mobile Probe

- Scan the area to be measured with the mobile probe (see «ScanCar», page 5) while observing the selected grid.

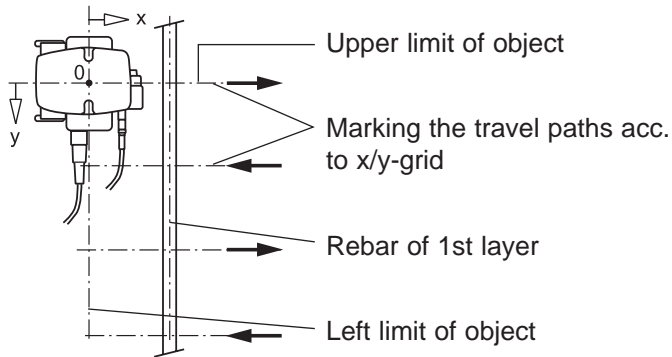

Fig. 5.14 Measuring with the mobile probe



Direction of travel:

The front of the mobile probe is where the single wheel is.
The front must always be opposite the x or y axis. The direction of travel can be forward or backward.

- Pressing the END key calls the top left corner of the measuring area:

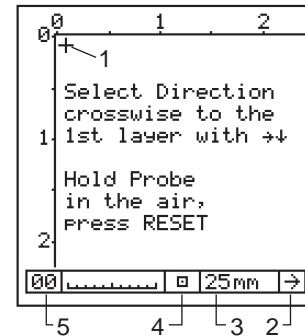

The x/y-coordinates are indicated in meters or feet. One page contains 16 x 15 measured values that are displayed in grey scale and stored. The memory has a storage capacity of 500 pages. The number of the remaining free pages is indicated in the measuring display (see Fig. 5.13).

Fig. 5.15 Measuring area before measuring

Key:

1 Cursor:

Press the \uparrow , \downarrow , \leftarrow , \rightarrow keys briefly to move the cursor step by step.
Keep the \uparrow , \downarrow , \leftarrow , \rightarrow keys permanently pressed to go to the next pages.

2 The arrow indicates the measuring direction. With the \uparrow , \downarrow , \leftarrow , \rightarrow keys the measuring direction can be changed.

3 Current concrete cover

4 Grey scale symbol of the current concrete cover

5 From 10 m in direction x, 10 a.s.o. is displayed.

- Follow the instructions in the display of Fig. 5.15 before starting measuring.

Scanning the measuring area with display of the concrete covers



After every manual or automatic change of the arrow direction, **RESET** must be pressed. See also «RESET process», page 10.

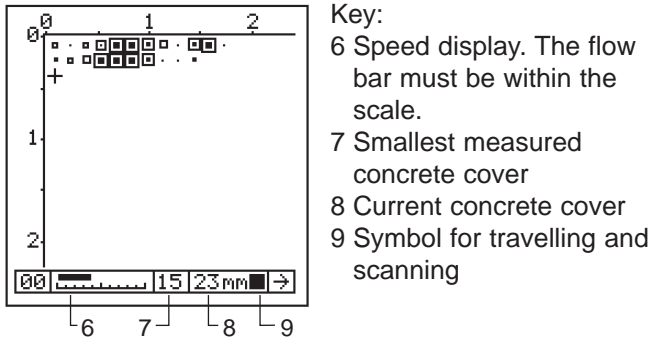

Fig. 5.16 Measuring area after measuring

- If the rebars of the first layer run in a vertical direction as shown in Fig. 5.14, the travel paths must be positioned horizontally with the selected grid spacing in direction y. Move the mobile probe along these paths. In Fig. 5.16, pos. 7, the smallest concrete cover measured in a grid field is displayed and stored automatically as grey scale.
- After having finished one row, press the ↓ key. The cursor jumps to below the last field and the arrow direction changes automatically.

- Once the second row at the edge of the measuring area (y-axis) is completed, the cursor jumps to below the last field and the arrow direction changes automatically.
- The indicating device operates in the same way if the travel paths are positioned vertically, i.e. if measuring is performed in direction y.
- If a hindrance prevents the measurements, you can shift the cursor by the size of the obstacle.
 - Individual values can be deleted by positioning the cursor on the respective value and pressing the PRINT/STORE key for two seconds.
 - You can subsequently expand the object opened last in the x and y-direction on new pages comprising 240 measured values.
 - For all previous objects, measured values can only be entered in pages that are not yet full.
 - If the measurement cannot be started in the top left corner (x and y = 0) you can move the cursor to the starting position using the corresponding arrow keys.
 - If you want to reserve pages that will be needed later, each page has to be selected separately. To confirm the reservation you can set a grey scale symbol in the second row using the PRINT/STORE key. The grey scale symbol can be overwritten or deleted at any time.

5.5.2 Measuring with the Universal Probe

Measuring with grid can also be performed with the probe only, i.e. without path measuring (ScanCar). To do this, the x/y-grid has to be drawn on the concrete surface to be measured.

- Carry out the same settings as for «Measuring with the Mobile Probe», page 18.
- During measuring, the grid fields must be scanned with the universal probe.
- Please note that the smallest concrete cover measured in a grid field is always displayed (see Fig. 5.16, Pos. 7). Store this value using the PRINT/STORE key.

5.6 Data Output

Characteristics of the menu items:

5.6.1 Object Select

All object numbers used are listed.

5.6.2 Object Display

An object which has been selected from the list is called from the memory and displayed.

5.6.3 Object Print

The object can be printed with the printers listed below. They can be connected directly to the indicating device.

- Hewlett Packard Deskjet printers for graphic and numerical printout.
 - EPSON printers for numerical printout.
- Printers with a parallel interface require the serial/parallel interface converter, Art. No. 390 00 188. For printers with a serial interface, use the printer cable Art. No. 330 00 460.
- Select the corresponding function in the «Printer select» submenu.

Below, you will find examples of printouts of various objects.

```
*****  
*          PROFOMETER 5          *  
*      Model  SCANLOG          *  
*****  
  
Date:  
  
Object No. 100418  
d= 16mm  
Neighb. bar corr.: a= 70mm  
Number n= 15/Mean x= 27mm  
Min/Max= 19/33mm  
sa= +/-3.6mm  
s (min)= 25mm  
smaller s (min)= 33%  
  
23  
26  
24  
19  
23  
26  
29
```

Fig. 5.17 Printout of a «Measure w. Statistics» object

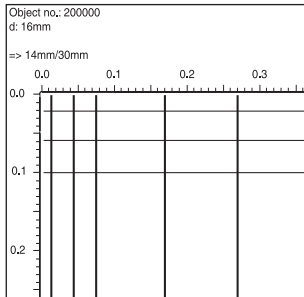

Fig. 5.18 Printout of a CyberScan object

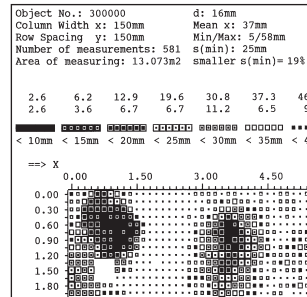

Fig. 5.19 Printout of «Measure with Grid» object

5.6.4 Object to PC

Data can be transferred to PC and edited by use of the programme ProVista supplied on a data carrier. Instructions on the installation of the software and the operation can be found on the data carrier. For data transfer to the RS232 interface use the transfer cable, Art. No. 330 00 456. If only a USB interface is available an additional RS232/USB adapter, Art. No. 390 00 540 must be used. Information on the installation of the adapter can be found on the included CD.

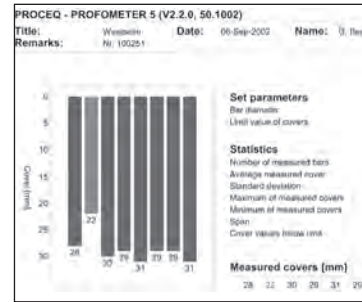

Fig. 5.20 Object «Measuring with statistics»

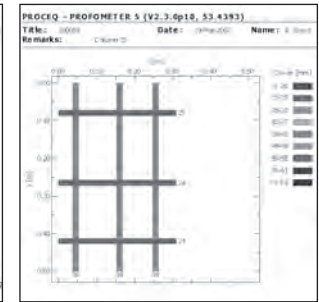

Fig. 5.21 «Cyberscan» object

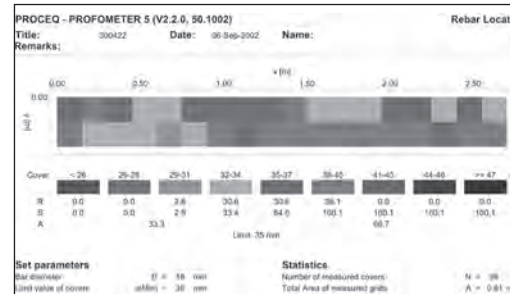

Fig. 5.22 Object «Measuring with grid»

5.6.5 Clear memory

Objects cannot be deleted individually



You can only delete the entire memory contents. This action cannot be undone after it has been confirmed.

6 Maintenance and Storage

6.1 Cleaning



Warning!

Never immerse the indicating device or measuring equipment in water or wash it under a running tap! Use neither abrasives nor solvents for cleaning!

- Clean the indicating device and measuring equipment with a clean, dry cloth after use.
- Clean dirty input sockets and connectors with a clean, dry brush.

6.2 Performance Check

- Check the cables for damage.
- All measuring functions can be checked with the test block, Art. no. 390 00 270.
- If the battery life symbol is only $\frac{1}{4}$ black a set of new batteries should be taken on site.

6.3 Storage

- Store the indicating device and measuring equipment in the original case and in a clean, dust-free room.
- If the unit is not used for a long period of time, remove the batteries.

7 Data

7.1 Form of Delivery

	Model S	Model SCANLOG
Article no.	390 00 050	390 00 054
Indicating device	●	●
Carrying strap	●	●
Universal probe incl. protective film	●	●
Probe cable 1.5 m	●	●
ScanCar probe carriage with path measuring cable 1.55 m	Option	●
Interface converter serial/parallel incl. 2.0 m cable	Option	●
Transfer cable 1.5 m	●	●
USB-memory stick for data transfer	●	●
Headset	●	●
Protection sleeve for display unit	●	●
Operating instructions	●	●
Carrying case 415 x 500 x 125 mm	●	●
Total weight	4.2 kg	4.5 kg



Model S



Model SCANLOG

7.2 Accessories / Spare Parts

Designation	Article no.
Extension rod for universal probe and ScanCar	390 00 076
Test block	390 00 270
Marking pen	390 00 280
Protective film for universal probe	390 00 084
Headset	390 00 085
Protection sleeve for indicating device	330 00 470
Transfer cable 9/9-poles	330 00 456
Printer cable 9/9+25-poles for printer with serial interface	330 00 460
Interface converter serial/parallel for printer with parallel interface	390 00 188
RS232/USB adapter	390 00 540
Upgrading from model S to model SCANLOG	390 00 090

7.3 Technical Data

7.3.1 Indicating Device Model S

- Non-volatile data memory for 40 000 measured values, can be divided into 60 objects
- Graphics LCD, 128x128 pixels with backlight
- Interface RS 232
- Software for direct printing. ProVista software for data transfer to PC and editing
- Power supply with 6 batteries, 1,5V, LR6 for an operating time of approx. 45h, or 30h with switched on backlight. We suggest to use alkaline batteries
- Permissible ambient temperature for the whole device: -10 °C to +60 °C

7.3.2 Indicating Device Model SCANLOG

Model SCANLOG is identical to model S but additionally includes:

- «CyberScan» function for displaying the concrete cover on the indicating device
- «Measure with Grid» function for grey scale display of the concrete cover
- Extended data memory:
 - Storage areas for «CyberScan»
 - Storage areas for «Measure with Grid»: 500 pages with 16 x 15 = 240 measured values each
 - The maximum number of objects, however, remains 60; #200 000 and 300 000 are demo objects