

**Betonprüfhammer**  
**Concrete Test Hammer**  
**Scléromètre à béton**  
**N/NR - L/LR**



Bedienungsanleitung

Operating Instructions

Mode d'emploi



N/L



NR/LR

ISO  
9001

proceq

PROCEQ SA  
Riesbachstrasse 57  
Postfach 936  
CH-8034 Zürich  
Switzerland

Tel.: +41 (0)1 389 98 00  
Fax: +41 (0)1 389 98 12  
E-Mail: [info@proceq.com](mailto:info@proceq.com)  
Internet: [www.proceq.com](http://www.proceq.com)

Änderungen vorbehalten  
Subject to change  
Sous réserve de modifications

**English**

vakat

# Contents

<b>1</b>	<b>Safety</b> .....	<b>2</b>	<b>4</b>	<b>Data</b> .....	<b>16</b>
	General Information .....	2		Form of Delivery .....	16
	Liability .....	2		Accessories .....	16
	Safety Regulations .....	3		Technical Data .....	16
	Standards and Regulations Applied .....	3			
<b>2</b>	<b>Measurement</b> .....	<b>4</b>			
	Measuring Principle .....	4			
	Measuring Procedure .....	4			
	Outputting and Evaluating Data .....	6			
	Conversion Curves .....	6			
	Factors Affecting the Values .....	10			
<b>3</b>	<b>Maintenance</b> .....	<b>12</b>			
	Performance Check .....	12			
	Cleaning After Use .....	12			
	Fitting a New Recording Paper Roll .....	12			
	Maintenance Procedure .....	13			

# 1 Safety

## 1.1 General Information

### 1.1.1 Basic Information

The concrete test hammer is designed according to state-of-the-art technology and the recognized safety regulations. Please read through these operating instructions carefully before initial startup. They contain important information about safety, use and maintenance of the concrete test hammer.

### 1.1.2 Designated Use

The concrete test hammer is a mechanical device used for performing rapid, non-destructive quality testing on materials in accordance with the customer's specifications; in most cases, however, the material involved is concrete.

The device is to be used exclusively on the surfaces to be tested and on the testing anvil.

## 1.2 Liability

Our "General Terms and Conditions of Sale and Delivery" apply in all cases. Warranty and liability claims arising from personal injury and damage to property cannot be upheld if they are due to one or more of the following causes:

- Failure to use the concrete test hammer in accordance with its designated use
- Incorrect performance check, operation and maintenance of the concrete test hammer
- Failure to adhere to the sections of the operating instructions dealing with the performance check, operation and maintenance of the concrete test hammer
- Unauthorized structural modifications to the concrete test hammer
- Serious damage resulting from the effects of foreign bodies, accidents, vandalism and force majeure

## 1.3 Safety Regulations

### 1.3.1 General Information

- Perform the prescribed maintenance work on schedule.
- Carry out a performance check once the maintenance work has been completed.
- Handle and dispose of lubricants and cleaning agents responsibly.

### 1.3.2 Unauthorized Operators

The concrete test hammer is not allowed to be operated by children and anyone under the influence of alcohol, drugs or pharmaceutical preparations.

Anyone who is not familiar with the operating instructions must be supervised when using the concrete test hammer.

### 1.3.3 Safety Icons

The following icons are used in conjunction with all important safety notes in these operating instructions.



#### ***Danger!***

***This note indicates a risk of serious or fatal injury in the event that certain rules of behavior are disregarded.***



#### ***Warning!***

***This note warns you about the risk of material damage, financial loss and legal penalties (e.g. loss of warranty rights, liability cases, etc.).***



***This denotes important information.***

## 1.4 Standards and Regulations Applied

- |                     |               |
|---------------------|---------------|
| - ISO/DIS 8045      | International |
| - EN 12 504-2       | Europe        |
| - ENV 206           | Europe        |
| - BS 1881, part 202 | Great Britain |
| - DIN 1048, part 2  | Germany       |
| - ASTM C 805        | USA           |
| - NFP 18-417        | France        |
| - B 15-225          | Belgium       |
| - JGJ/T 23-2001     | China         |
| - JJG 817-1993      | China         |

## 2 Measurement

### 2.1 Measuring Principle

The device measures the rebound value R. There is a specific relationship between this value and the hardness and strength of the concrete.

The following factors must be taken into account when ascertaining rebound values R:

- Impact direction: horizontal, vertically upwards or downwards
- Age of the concrete
- Size and shape of the comparison sample (cube, cylinder)

Models N and NR can be used for testing:

- Concrete items 100 mm or more in thickness
- Concrete with a maximum particle size  $\leq 32$  mm

Models L and LR can be used for testing:

- Items with small dimensions (e.g. thin-walled items with a thickness from 50 to 100 mm)



*If necessary, clamp the items to be tested prior to measurement in order to prevent the material deflecting.*

- Items made from artificial stone which are sensitive to impacts



*Preferably perform measurements at temperatures between 10°C and 50°C only.*

### 2.2 Measuring Procedure

The items (in brackets) are illustrated in Fig. 2.4 on page 5. Perform a few test impacts with the concrete test hammer on a smooth, hard surface before taking any measurements which you are going to evaluate.



- Use the grindstone to smoothen the test surface.

Fig. 2.1 Preparing the test surface



#### **Warning!**

*The impact plunger (1) generates a recoil when it deploys. Always hold the concrete test hammer in both hands!*



- Position the concrete test hammer perpendicular to the test surface.
- Deploy the impact plunger (1) by pushing the concrete test hammer towards the test surface until the pushbutton springs out.

Fig. 2.2 Deploying the impact plunger (1) (model NR)





**Danger!**  
**Always hold the concrete test hammer in both hands, perpendicular to the test surface, before you trigger the impact!**



Each test surface should be tested with at least 8 to 10 impacts.

The individual impact points must be spaced at least 20 mm apart.



- Position the concrete test hammer perpendicular to and against the test surface. Push the concrete test hammer against the test surface at moderate speed until the impact is triggered.

Fig 2.3 Performing the test (illustration shows model NR)

- If you are using models N and L, press the pushbutton (6) to lock the impact plunger (1) after every impact. Then read off and note down the rebound value R indicated by the pointer (4) on the scale (19).
- If you are using models NR and LR, the rebound value R is automatically printed on the recording paper. It is only necessary to lock the impact plunger (1) using the push button (6) after the last impact.

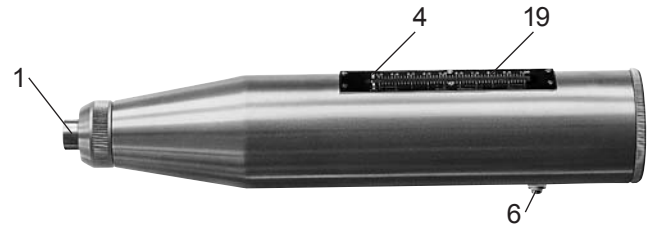

Fig. 2.4 Reading the test result from the scale (19) on models N and L

## 2.3 Outputting and Evaluating Data

### 2.3.1 Output

Models N and L

After every impact, the rebound value R is displayed by the pointer (4) on the scale (19) of the device.

Models NR and LR

The rebound value R is automatically registered on the recording paper.

It is possible to record about 4000 test impacts on each roll.

### 2.3.2 Evaluation

Take the average of the 8 – 10 rebound values R which you have measured.



*Do not include values which are too high or too low (the lowest and highest values) in your calculation of the average value.*

• Determine which conversion curve is appropriate for the selected body shape (see Fig. 2.5 to Fig. 2.10, page 7 to page 9). Then, using the average rebound value  $R_m$  and the selected conversion curve, read off the average compressive strength.



*Note the impact direction!*



*The average compressive strength is subject to a dispersion ( $\pm 4.5 \text{ N/mm}^2$  to  $\pm 8 \text{ N/mm}^2$ ).*

## 2.4 Conversion Curves

### 2.4.1 Derivation of the Conversion Curves

The conversion curves (Fig. 2.5, to Fig. 2.10) for the concrete test hammer are based on measurements taken on very many sample cubes. The rebound values R of the sample cubes were measured using the concrete test hammer. Then the compressive strength was ascertained on a pressure testing machine. In each test, at least 10 test hammer impacts were performed on one side of the test cube which was lightly clamped in the press.

### 2.4.2 Validity of the Conversion Curves

- Standard concrete made from Portland or blast furnace slag cement with sand gravel (maximum particle size dia.  $\leq 32 \text{ mm}$ )
- Smooth, dry surface
- Age: 14 - 56 days

### Empirical values:

The conversion curve is practically independent of the:

- Cement content of the concrete,
- Particle gradation,
- Diameter of the largest particle in the fine gravel mixture, providing the diameter of the maximum particle is  $\leq 32 \text{ mm}$ ,
- Water/cement ratio

**Conversion Curves, Concrete Test Hammer Model N/NR**  
Concrete pressure resistance of a cylinder after 14 - 56 days

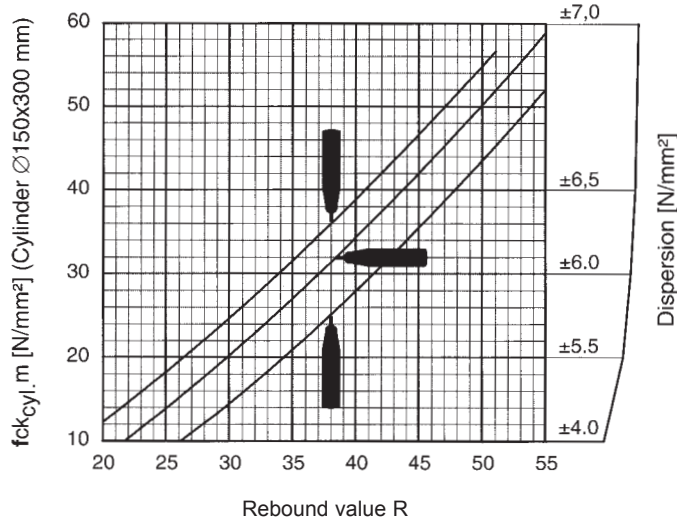

Fig. 2.5 Model N/NR: Conversion curves based on the average compressive strength of a cylinder and the rebound value  $R$

$f_{ck_{cyl.m}}$ : Average pressure resistance of a cylinder (probable value)



The concrete test hammers shown in Fig. 2.5 and Fig. 2.6 indicate the impact direction.

**Conversion Curves, Concrete Test Hammer Model L/L R**  
Concrete pressure resistance of a cylinder after 14 - 56 days

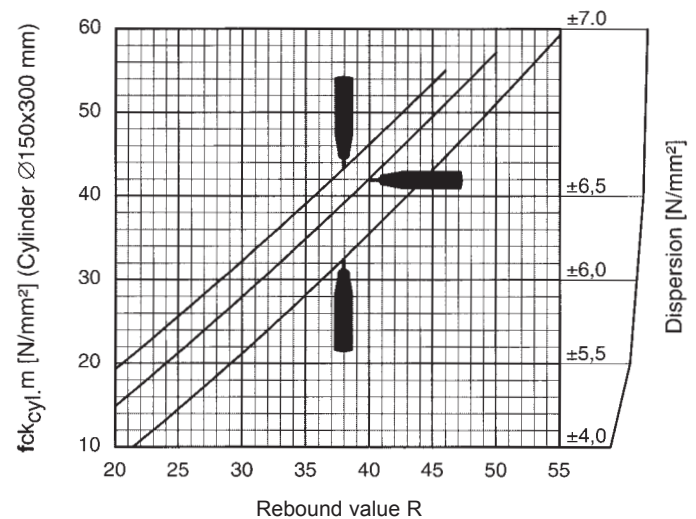

Fig. 2.6 Model L/LR: Conversion curves based on the average pressure resistance of a cylinder and the rebound value  $R$

**Limits of Dispersion**

$f_{ck_{cyl.}}$ : The max. and min. values are set so 80 % of all test results are included.

**Conversion Curves, Concrete Test Hammer Model N/NR**  
Concrete pressure resistance of a cube after 14 - 56 days

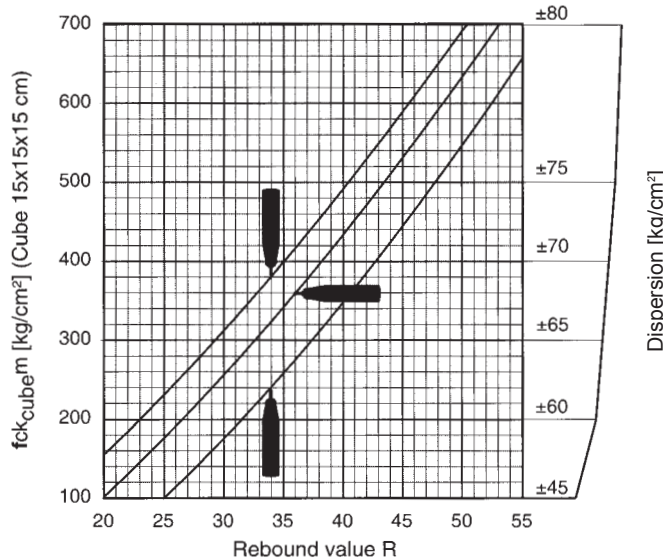

Fig. 2.7 Model N/NR: Conversion curves based on the average compressive strength of a cube and the rebound value R

$f_{ck\_cube\ m}$ : Average pressure resistance of a cube (probable value)



The concrete test hammers shown in Fig. 2.7 and Fig. 2.8 indicate the impact direction.

**Conversion Curves, Concrete Test Hammer Model L/LR**  
Concrete pressure resistance of a cube after 14 - 56 days

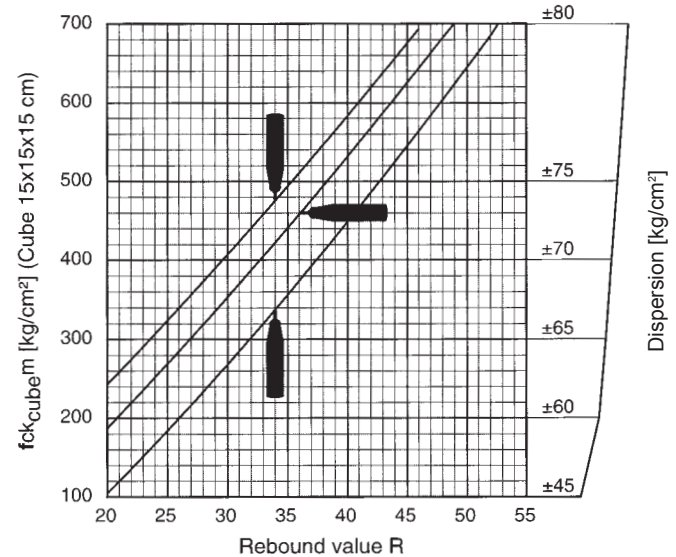

Fig. 2.8 Model L/LR: Conversion curves based on the average compressive strength of a cube and the rebound value R

**Limits of Dispersion**

$f_{ck\_cube}$ : The max. and min. values are set so 80% of all test results are included.

## Conversion Curves, Concrete Test Hammer Model N/NR

Concrete pressure resistance of a cylinder after 14 - 56 days

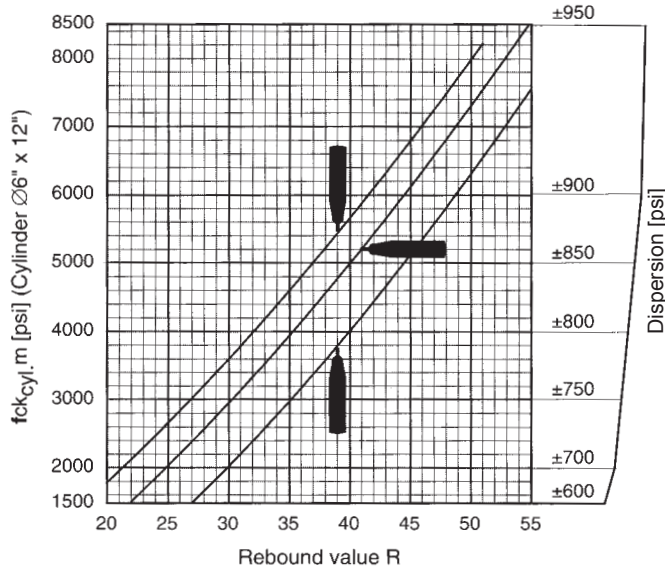

Fig. 2.9 Model N/NR: Conversion curves based on the average compressive strength of a cylinder and the rebound value R

$f_{ck\_cyl.m}$ : Average pressure resistance of a cylinder (probable value)



The concrete test hammers shown in Fig. 2.9 and Fig. 2.10 indicate the impact direction.

## Conversion Curves, Concrete Test Hammer Model L/LR

Concrete pressure resistance of a cylinder after 14 - 56 days

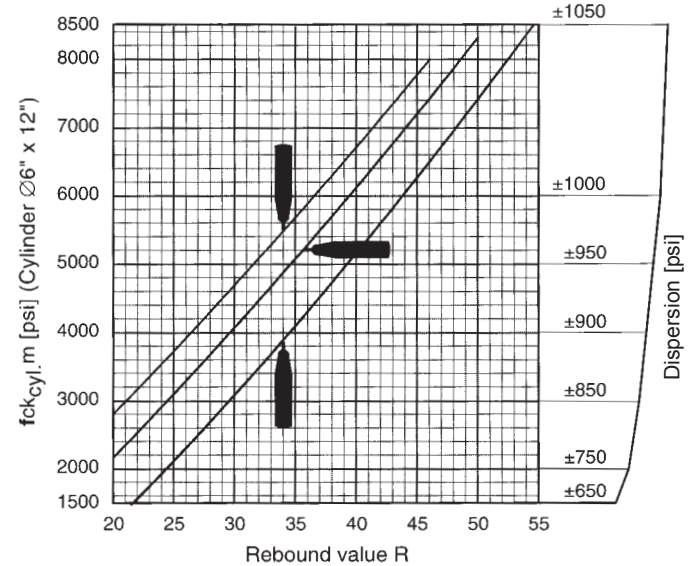

Fig. 2.10 Model L/LR: Conversion curves based on the average compressive strength of a cylinder and the rebound value R

### Limits of Dispersion

$f_{ck\_cube}$ : The max. and min. values are set so 80% of all test results are included.

## 2.5 Factors Affecting the Values

### 2.5.1 Direction of impact

The measured rebound value R is dependent on the impact direction.

### 2.5.2 Shape coefficient

The compressive strength measured in a pressure testing machine depends on the shape and size of the sample.



*The samples prescribed for use in the particular country must be taken into account when converting the rebound value R into compressive strength.*

In the conversion curves on page 7 to page 11, the values for compressive strength are specified for cylinders (Ø 150 x 300 mm or Ø 6" x 12") and for cubes (length of side 15 cm). The following shape coefficients are familiar from the literature:

Cube	150 mm	200 mm	300 mm
Shape coefficient	<b>1,00</b> 1.25	0,95 1.19	0,85 1.06
Cylinder	Ø 150x300 mm Ø 6"x12"	Ø 100x200 mm	Ø 200x200 mm
Shape coefficient	0,80 <b>1.00</b>	0,85 1.06	0,95 1.19
Drill core	Ø 50x56 mm	Ø 100x100 mm	Ø 150x150 mm
Shape coefficient	1,04 1.30	1,02 1.28	1,00 1.25

Example:

A cube with a length of side of 200 mm is used for the determination of the compressive strength with the pressure testing machine.

In this case the strength values shown in the conversion curves in Fig. 2.9 and Fig. 2.10 on page 9 (for cylinders Ø 6"x12") must be multiplied by the shape coefficient of 1.19.

### 2.5.3 Time coefficient

The age of the concrete and its carbonate penetration depth can significantly increase the measured rebound values R. It is possible to obtain accurate values for the effective strength by removing the hard, carbonate-impregnated surface layer using a manual grinding machine over a surface area of about Ø 120 mm and performing the measurement on the non-carbonate-impregnated concrete. The time coefficient, i.e. the amount of the increased rebound values R, can be obtained by taking additional measurements on the carbonate-impregnated surface.

$$\text{Time coeff. } Z_f = \frac{R_{m \text{ carb.}}}{R_{m \text{ n.c.}}} \Rightarrow R_{m \text{ n.c.}} = \frac{R_{m \text{ carb.}}}{Z_f}$$

$R_{m \text{ carb.}}$ : Average rebound value R, measured on carbonate-impregnated concrete surface

$R_{m \text{ n.c.}}$ : Average rebound value R, measured on non-carbonate-impregnated concrete surface

(Factor on the base of the chinese standard JGJ/T 23-2001, see our special info-leaflet).

### 2.5.4 Special Cases

Experience has shown that deviations from the normal conversion curves occur under the following circumstances:

- Artificial stone products with an unusual concrete composition and small dimensions. It is recommended that a separate series of tests should be performed for each product in order to determine the relationship between the rebound value R and the compressive strength.
- Aggregates made from low strength, lightweight or cleavable stone (e.g. pumice, brick rubble, gneiss) result in a strength value lower than shown on the conversion curve.
- Gravel with extremely smooth, polished surfaces and a spherical shape results in values for compressive strength which are lower than those ascertained by the rebound measurements.
- A strong, dry mixed concrete (i.e. with low sand content) which has not been placed adequately processed may contain lumps of gravel which are not visible from the surface. These affect the strength of the concrete without however influencing the rebound values R.
- The concrete test hammer gives inadequate rebound values R on concrete from which the form has just been removed, which is wet or which has hardened under water. The concrete must be dried before the test.
- Very high values for compressive strength ( $> 70 \text{ N/mm}^2$ ) can be achieved by adding pulverized fuel ash or silica fume. However, these strengths cannot reliably be ascertained using the rebound value R measured by the concrete test hammer.

### 2.5.5 Conversion Curves for Special Cases

The recommended course in special cases is to prepare a separate conversion curve.

- Clamp the sample in a pressure testing machine and apply a preload of about 40 kN vertically to the direction in which the concrete had been poured in.
- Measure the rebound hardness by applying as many test impacts as possible to the sides.

The only way to achieve a meaningful result is to measure the rebound values R and the compressive strength of several samples.



*Concrete is a very inhomogeneous material. Samples made from the same batch of concrete and stored together can reveal discrepancies of  $\pm 15\%$  when tested in the pressure testing machine.*

- Discard the lowest and highest values and calculate the average  $R_m$ .
  - Determine the compressive strength of the sample using the pressure testing machine and ascertain the average value  $f_{ckm}$ .  
The pair of values  $R_m / f_{ckm}$  applies to a certain range of the measured rebound value R.
- It is necessary to test samples of differing qualities and/or ages in order to prepare a new conversion curve for the entire range of rebound values from  $R = 20$  to  $R = 55$ .
- Determine the curve with the pairs of values  $R_m / f_{ckm}$  (e.g. EXCEL in the RGP function).

## 3 Maintenance

### 3.1 Performance Check

If possible, carry out the performance check every time before you use the device, however at least every 1000 impacts or every 3 months.



- Place the testing anvil on a hard, smooth surface (e.g. stone floor).
- Clean the contact surfaces of the anvil and the impact plunger.
- Perform about 10 impacts with the concrete test hammer and check the result against the calibration value specified on the testing anvil.

Fig. 3.1 Performance check of the concrete test hammer (model N/L shown)



Proceed as described in "Maintenance Procedure" on page 13 if the values are not within the tolerance range specified on the testing anvil.

### 3.2 Cleaning After Use

- Deploy the impact plunger (1) as described in Fig. 3.2, "Measuring Procedure" on page 4.
- Wipe the impact plunger (1) and housing (3) using a clean cloth.



#### **Warning!**

*Never immerse the device in water or wash it under a running tap! Do not use either abrasives or solvents for cleaning!*

### 3.3 Fitting a New Recording Paper Roll



*The following instructions only apply to models NR and LR!*

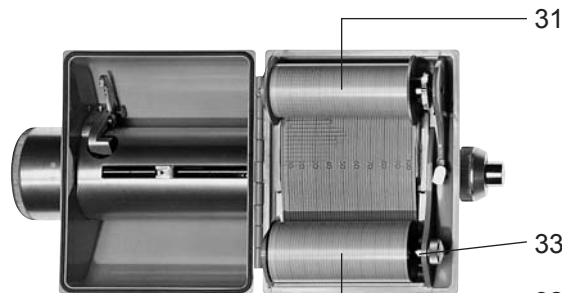

Fig. 3.2 Fitting a new recording paper roll



- Turn knurled screw (33) to rewind the recording paper from reel (31) to reel (32).
- Pull out the knurled screw (33) until it locks and then remove the reel (32).
- Insert a new roll with the text "Value 100" on the side closest to the knurled screw (33).
- If the knurled screw (33) does not engage, turn the reel (32) until the knurled screw (33) starts turning with it as well.
- Cut off the start of the paper strip like an arrow and insert it into the slot in reel (31).
- Tension the paper by turning the reel (31).

### 3.4 Maintenance Procedure

We recommend that the concrete test hammer should be checked for wear after 2 years at most and be cleaned. Do this as described below.



*The concrete test hammer can either be sent to a service center authorized by the vendor or else it can be maintained by the operator according to the following description.*

The items (in brackets) are illustrated in Fig. 3.3, "Lengthways section through the concrete test hammer" on page 15.

#### 3.4.1 Stripping Down



##### **Warning!**

*Never strip down, adjust or clean the pointer and pointer rod (4) (see Fig. 3.3, page 15), otherwise the pointer friction may change. Special tools would be required to readjust it.*

- Position the concrete test hammer perpendicular to the surface.



##### **Danger!**

*The impact plunger (1) generates a recoil when it deploys. Therefore always hold the concrete test hammer with both hands! Always direct the impact plunger (1) against a hard surface!*

- Deploy the impact plunger (1) by pushing the concrete test hammer towards the surface until the pushbutton (6) springs out.
- Unscrew the cap (9) and remove the two-part ring (10).
- Unscrew the cover (11) and remove the compression spring (12).
- Press the pawl (13) and pull the system vertically up and out of the housing (3).
- Lightly strike the impact plunger (1) with the hammer mass (14) to release the impact plunger (1) from the hammer guide bar (7). The retaining spring (15) comes free.

- Pull the hammer mass (14) off the hammer guide bar together with the impact spring (16) and sleeve (17).
- Remove the felt ring (18) from the cap (9).

### 3.4.2 Cleaning

- Immerse all parts except for the housing (3) in kerosene and clean them using a brush.
- Use a round brush (copper bristles) to clean the hole in the impact plunger (1) and in the hammer mass (14) thoroughly.
- Let the fluid drip off the parts and then rub them dry with a clean, dry cloth.
- Use a clean, dry cloth to clean the inside and outside of the housing (3).

### 3.4.3 Assembly

- Before assembling the hammer guide bar (7), lubricate it slightly with a low viscosity oil (one or two drops is ample; viscosity ISO 22, e.g. Shell Tellus Oil 22).
- Insert a new felt ring (18) into the cap (9).
- Apply a small amount of grease to the screw head of the screw (20).
- Slide the hammer guide bar (7) through the hammer mass (14).
- Insert the retaining spring (15) into the hole in the impact plunger (1).

- Slide the hammer guide bar (7) into the hole in the impact plunger (1) and push it further in until noticeable resistance is encountered.



*Prior to and during installation of the system in the housing (3), make sure that the hammer (14) does not get held by the pawl (13).  
Hint: For this purpose press pawl (13) briefly.*

- Install the system vertically downwards in the housing (3).
- Insert the compression spring (12) and screw the rear cover (11) into the housing (3).
- Insert the two-part ring (10) into the groove in the sleeve (17) and screw on the cap (9).
- Carry out a performance check.



*Send in the device for repair if the maintenance you perform does not result in correct function and achievement of the calibration values specified on the testing anvil.*

### 3.4.4 Concrete Test Hammer Model N/L

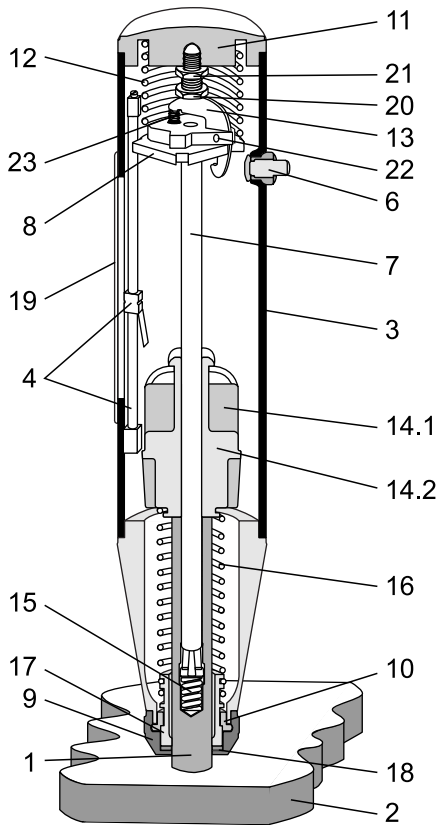

Fig. 3.3 Lengthways section through the concrete test hammer

#### Key:

- 1 Impact Plunger
- 2 Test surface
- 3 Housing
- 4 Rider with guide rod
- 5 Not used
- 6 Push button, complete
- 7 Hammer guide bar
- 8 Guide disk
- 9 Cap (for models L and LR red)
- 10 Two-part ring
- 11 Rear Cover (for models L and LR red)
- 12 Compression spring
- 13 Pawl
- 14 Hammer mass: 14.1 model N, 14.2 model L
- 15 Retaining spring
- 16 Impact spring
- 17 Guide sleeve
- 18 Felt washer
- 19 Plexiglas window
- 20 Trip screw
- 21 Lock nut
- 22 Pin
- 23 Pawl spring

## 4 Data

### 4.1 Form of Delivery

Concrete test hammer	Model N	Model NR	Model L	Model LR
Artikle-no.	310 01 000	310 02 000	310 03 000	310 04 000
Total weight	1,7 kg	2,6 kg	1,4 kg	2,4 kg
Carrying case, W x H x D	325 x 125 x 140 mm	325 x 295 x 105 mm	325 x 125 x 140 mm	325 x 295 x 105 mm
Grindstone	1 pce.	1 pce.	1 pce.	1 pce.
Recording paper	–	3 rolls	–	3 rolls

### 4.2 Accessoires

Concrete test hammer	Model N	Model NR	Model L	Model LR
	Accessory article number			
Testing anvil	310 09 000	310 09 000	310 09 000	310 09 000
Recording paper, pack of 5 rolls	–	310 99 072	–	310 99 072

### 4.3 Technical Data

Concrete test hammer	Model N	Model NR	Model L	Model LR
Impact energy	2,207 Nm		0,735 Nm	
Measuring range	10 to 70 N/mm <sup>2</sup> resistance to pressure		10 to 70 N/mm <sup>2</sup> resistance to pressure	

